

P/N: FAT74081

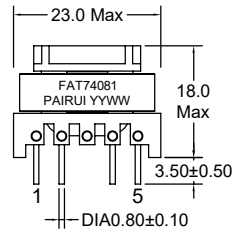

Outline Dimensions(Unit:mm)



Orthographic view

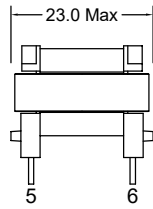

Side view

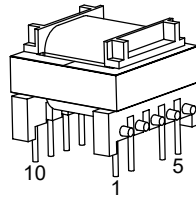

Stereogram

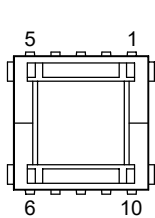

Top view

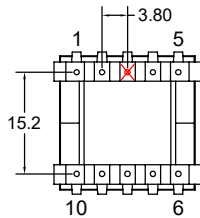

Bottom view

REMARK:

1. Fixed Core With 2Ts Tape.
2. Pin 3 removed.
3. Product vacuum impregnation.

Electronical Schematic

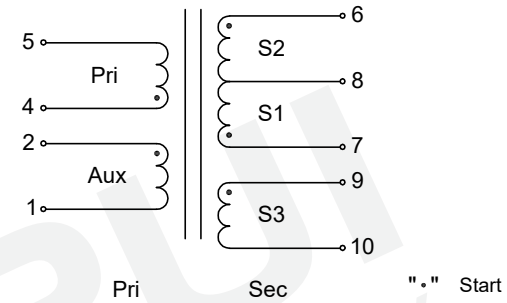

General Properties:

- Operating Temperature:-40°C to +105°C.
- Storage Temperature:-25°C to +85°C.
- Insulation Class:B.

Wave Soldering

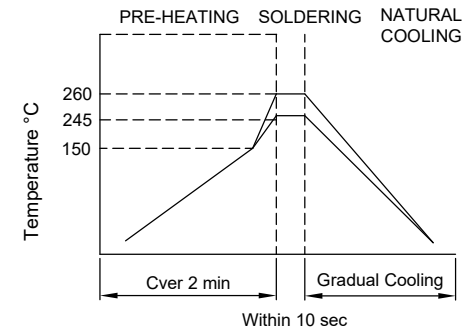

Note:

- 1.Never Contact the ceramic with the iron tip:
- 2.1.0mm tip diameter(max).

Electrical Characteristics

- Inductance : L4-5= 1.30mH ±10%,at 1KHz,0.3V.
- D.C.Resistance : 1-2= 0.20 ohms Max.
- 4-5= 1.30 ohms Max.
- 6-7= 0.016 ohms Max.
- 9-10= 0.016 ohms Max.
- Turns Ratio : Pri:Aux:S1:S2:S3=1:0.213:0.05:0.075:0.175±2%,at 20KHz,1V.
- Hipot : Pri-Sec : 4000VAC/5mA/1S.
- Pri&Sec-Core : 1000VAC/5mA/1S.
- Pri-Aux : 1000VAC/5mA/1S.

				Tianchang Fuan Electronic Co Ltd www.fuantronics.net TEL: +86-550-7814888 FAX:+86-550-7831133	 Tolerances unless otherwise specified: (.X)±0.50 (XX)±0.25 Unit of measurement: mm	Make: Qiumei.Liu Checked: Beson. zhan Approved: Anson. zhan	<b>DRAWING TITLE</b> EF20 FLYBACK TRANSFORMER Material Number:	Customer P/N: Document/Rev: 2205011/00 Specification Sheet: 1 of 2 Date of Recognition: May/03/2022
REV	DESCRIPTION	APPD	DATE					

P/N: FAT74081



List of UL Certificate:

No.	Part Name	Mat'l Description	Supplier	UL Number
1	Bobbin	EF-2002/T375J/FAY01091	Chang Chun Plastics Co Ltd	E59481
2	Copper wire	xUEW/155 MW 79-C	JiangSu Dartong M & E Co Ltd	E237377
		Polysol 155 MW 79-C	Elektrisola Hangzhou Co Ltd	E258243
3	Triple insulated wire	TRW-B/130C	Great Leoflon Industrial Co Ltd	E211989
4	Core	EF20/10/6 HPP4	Anhui Hualin Magnetic Technology Go Ltd	N/A
		EF20/10/6 TP4	TDG	N/A
5	Tape	JY25-A(b)/130C(Faint Yellow)	Jingjiang Jingyi Adhesive Product Co Ltd	E246950
		CT*(b)(g)/130C(Faint Yellow)	JingJiang Yahua Pressure Sensitive Glue Co Ltd	E165111
6	Varnish	T-4260(a)/MW80-C	SuZhou TaiHu Electric Advanced Material Co Ltd	E228349

Label:

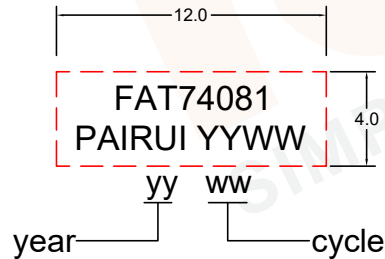

Remark:

- 1.Use Laser printing;
- 2.Clear writing and legibility, not easy to erase;
- 3.Border here means size range, not be printed;
- 4.Font:Arial;Height:1.20mm.

				Tianchang Fuan Electronic Co Ltd www.fuantronics.net TEL: +86-550-7814888 FAX: +86-550-7831133	 Tolerances unless otherwise specified: (.X)±0.50 (XX)±0.25 Unit of measurement: mm	Make: Qiumei.Liu Checked: Beson. zhan Approved: Anson. zhan	<b>DRAWING TITLE</b> EF20 FLYBACK TRANSFORMER Material Number:	Customer P/N: Document/Rev: 2205011/00 Specification Sheet: 2 of 2 Date of Recognition: May./03/2022
REV	DESCRIPTION	APPD	DATE					